

Plug

PowerTOP Xtra S

Part Number: 13522



MENNEKES

Elektrotechnik GmbH & Co. KG
Aloys-Mennekes-Straße 1
57399 KIRCHHUNDEM GERMANY
www.MENNEKES.org

Product Description

- screwless, with insulation displacement technology
- ergonomic enclosure design with nubbed grip zones
- rubberised cable gland with sealing
- strain relief and protection against kinking
- thread lock and safety slide
- area for self-adhesive labels
- the PowerTOP® Xtra S plug replaces the StarTOP plug 33

Technical Details

Plug - PowerTOP Xtra S	13522
Product series	PowerTOP Xtra S
Ampere	16 A
UL-Ampere	-
Number of Poles	5 P
Clock position	6 h
Voltage	400 V
Hertz	50-60 Hz
Current Type	AC
Protection Type	IP54
Contact carrier	Standard
Pilot contact	Without pilot contact
Connection	Insulation displacement technology - SafeCONTACT
Screw drive contact screw	Combination head screw (PZ2 and slotted)
Phase inverter plugs	Without phase inverter

Conductor cross-section min.	1 mm ²
Conductor cross-section max.	2.5 mm ²
Cable kink protection	Integrated in cable gland
Protective grommet	Without protective grommet
Protective cap	Without protective cap
Weight (net)	247 g
EAN / Identification number	4015394289197

Permissible ambient conditions

Permanent ambient temperature min. - max.	-25 °C - +40 °C
---	-----------------

Material properties

Cover	PA6 similar RAL 3013 red
Front part	PA6 similar RAL 3013 red

Material resistance

The material resistance overview can be found on the website in the section "Knowledge" → "Product knowledge" → "Materials"

Regulations and Standards

REACH (Regulation (EG) No. 1907/2006)	Information according to article 33 REACH: SVHC: Lead (CAS: 7439-92-1)
RoHS 2011/65/EU incl. 2015/863/EU	✓
POP Regulation (EU) 2019/1021	✓
Norm(s)	IEC 60309-2
Declaration of conformity	CE, UKCA
Test mark	VDE, EAC, CQC

Dimensional drawing

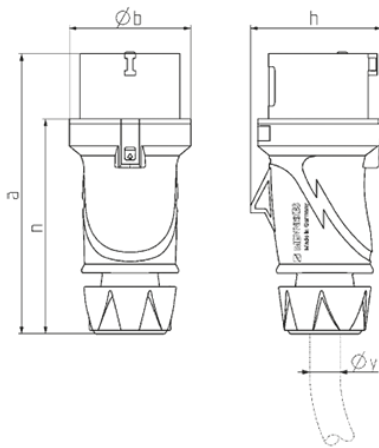

Drawing	Amp. Poles	16			32		
		3	4	5	3	4	5
2 MB 253							
Dim. in mm	a	154	163	163	196	196	196
	b	55	68	68	78	78	78
	h	58	70	74	81	81	86
	n	118	126	126	151	151	151
y min. from		7	8	8	10.5	10.5	13.5
to max. mm		-13	-15.5	-15.5	-18	-18	-20
Terminal for cond. cross		1	1	1	-2.5	-2.5	-2.5
section (mm ²) min.-max.		-2.5	-2.5	-2.5	-6	-6	-6